

Fieldpiece

Swivel Clamp Meter

OPERATOR'S MANUAL

Models SC55 SC56

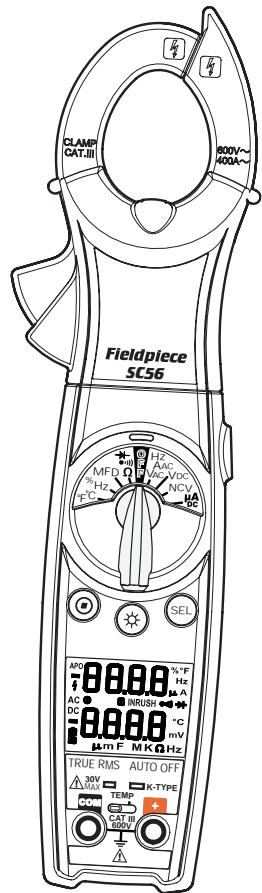

Quick Start

1. For electrical testing, connect test leads to "COM" and "+" jacks. For temperature testing, remove test leads and slide TEMP switch to the right.
2. Rotate the dial to your desired function. Press SEL to cycle through the parameters within the switch position.
3. Connect to test points and read measurement on display.

Certifications



IEC/EN61010-1
IEC/EN61010-2-032
EMC EN61326-1



C-Tick (N22675)



WEEE

CATIII 600V, class II and pollution degree 2 indoor use comply with CE, RoHS compliant.

Description

Your SC55 or SC56 is a swivel clamp multimeter specifically designed for the HVAC/R technician. The swivel on the SC55/SC56 allows you to get a good viewing angle on the display while taking amperage readings through the clamp, regardless of wire orientation. The SC55 and SC56 also contain the functions that are most relevant for an HVAC/R technician.

The unique temperature circuit allows the SC55/SC56 to get accurate temperature readings faster when moving from a rooftop to a freezer. The easily accessible field calibration allows you to calibrate the temperature on your SC55/SC56 without hassle.

Inrush current (SC56) allows you to get a reliable measurement of a motor's startup amp draw. You can use the inrush measurement to help diagnose a motor before it fails.

The jaw light (SC56) and backlight (SC56) make it easier to use in any lighting condition. True RMS (SC56) helps you take more accurate voltage readings on variable frequency drives.

Controls

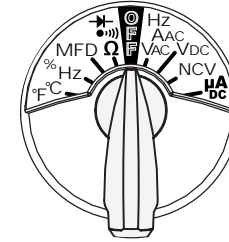

Rotate dial to the function you want to use.



Press to cycle through parameters within a dial position.



Press to illuminate backlight for 60 sec



Press to activate Inrush current capture mode (SC56).



Press to manually select resolution.



Press to freeze both displays (SC55).

Display

- Battery Life (replace 9V if blinking)
- APO Auto Power Off Enabled
- High Voltage Warning (+30V)
- Manual Range (RNG) Mode
- Data Hold Mode (Model SC55)
- Inrush Amps Mode (Model SC56)
- Continuity Test
- Diode Test
- Frequency Test (hertz)
- Resistance Test (ohms)
- Capacitance Test (farads)
- Duty Cycle Test (percentage)
- Micro Unit (10^{-6} , one millionth)
- Milli Unit (10^{-3} , one thousandth)
- Kilo Unit (10^3 , one thousand)
- Mega Unit (10^6 , one million)

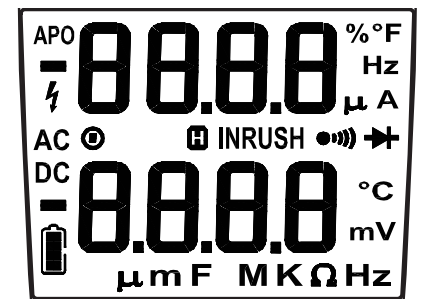

Safety Information

- Never ground yourself when taking electrical measurements. Do not touch exposed metal pipes, outlets, fixtures, etc., which might be at ground potential, while taking measurements. Keep your body isolated from ground by using dry clothing, rubber shoes, rubber mats, or any approved insulating material.
- Disconnect the test leads before opening the case. Inspect the test leads for damage to the insulation or exposed wire. Replace if suspect. Keep your fingers behind the finger guards on the probes while taking measurements.
- When disconnecting from a circuit, disconnect the "RED" lead first, then the common "BLACK" lead. Use one handed testing when possible. Work with others.
- Turn off power to the circuit under test before cutting, unsoldering, or breaking the circuit.
- Do not measure resistance (ohms) when circuit is powered. Isolate load by disconnecting from circuit.
- Disconnect the meter from the circuit before turning any inductor off, including motors, transformers, and solenoids. High voltage

transients can damage the meter beyond repair. Do not use during electrical storms.

- Do not apply more than rated voltages between input and ground.
 - Isolate capacitors from system and discharge them safely before testing.
- All voltage tests:** All voltage ranges will withstand up to 600V. Do not apply more than 600VDC or AC rms.

Symbols used:

- Caution, risk of electric shock
- Caution, refer to manual.
- Ground
- Double insulation

⚠ WARNINGS

DISCONNECT AND UNPLUG TEST LEADS before opening case. TEST NCV FUNCTION ON KNOWN LIVE WIRE before using. DO NOT APPLY VOLTAGE greater than 30VAC or 60VDC to the thermocouple or the jacks when the rotary dial is on °F. (Use only k-type thermocouples) REMOVE THE THERMOCOUPLE when taking voltage measurements. DISCONNECT TEST LEADS when measuring temperature. DO NOT APPLY VOLTAGE TO THE JACKS when the rotary dial is on microamps. Even low voltages can cause a current overload and potentially harm the meter.

Specifications

- Display:** 5000 count dual display with backlight
- Overrange:** (OL) or (-OL) is displayed
- Measurement rate:** 3.3 times per second, nominal
- Zero:** Automatic
- Operating environment:** 32°F to 122°F (0°C to 50°C) at <70% relative humidity
- Storage temperature:** -4°F to 140°F (-20°C to 60°C), 0 to 80% RH (with battery removed)
- Accuracy:** Stated accuracy @ 73°F ± 9°F (23°C ± 5°C), <75%RH
- Temperature coefficient:** 0.1 x (specified accuracy) per °C [0°C to 19°C (32°F to 66°F), 28°C to 50°C (82°F to 122°F)]
- APO (Auto Power Off):** Approx. 30 minutes
- Power:** Single standard 9-volt battery, NEDA 1604, JIS 006P, IEC 6F22
- Battery life:** 200 hours typical alkaline (SC55); 100 hours typical alkaline (SC56)
- Low battery indication:** Battery icon blinks and "LO.bt" is displayed when the battery voltage drops below the operating level
- Dimensions:** 258.3mm(H) x 71.2mm(W) x 42.7mm(D)
- Weight:** Approx. 278g including battery
- Overload protection:** 600 VDC or 600VAC rms unless otherwise stated

Functions

Temperature (°F/°C)

Plug any K-type thermocouple directly into the meter to measure temperature. Cold junction is located "inside meter" and allows for extremely accurate measurements even in rapidly changing ambient temperatures (going from rooftop to freezer). No adapter is required. See Temp Calibration section for calibration instructions.

- Range:** -30°F to 932°F, (-35°C to 500°C) **Resolution:** 0.1°
- Accuracy:** ±(1°F) 32°F to 120°F, ±(1°C) 0°C to 49°C ±(1%+2°F) 32°F to 572°F, ±(1%+1°C) 0°C to 300°C ±(2%+6°F) -30°F to 32°F, ±(2%+3°C) -35°C to 0°C ±(2%+6°F) 572°F to 932°F, ±(2%+3°C) 300°C to 500°C

Sensor type: K-type thermocouple
Overload protection: 30 VDC or 30VAC rms

Non Contact Voltage (NCV)

Use the non contact voltage (NCV) feature to test if a wire is hot or not. Always test on a known live source before using. A red LED blinks when beeping sound is emitted at >24VAC

AC Voltage Detection Range: 24VAC to 600VAC (50-60Hz)

Voltage AC (VAC) (50Hz-500Hz)

Test power lines (120, 220, 480), test 24V going to controls, and test for transformer failure.

- Ranges:** 500mV, 5V, 50V, 500V, 600V **Resolution:** 0.1mV
- Accuracy:** ±(1.2% + 8) 500mV range (50-60Hz) ±(1.2%+8), 5V, 50V, 500V; ±(1.5% + 8) 600V range
- True RMS:** model SC56 only **Crest factor:** ≤ 3
- Input impedance:** >100MΩ (500mV), 10MΩ (5V), 9.1MΩ (50V-600V)

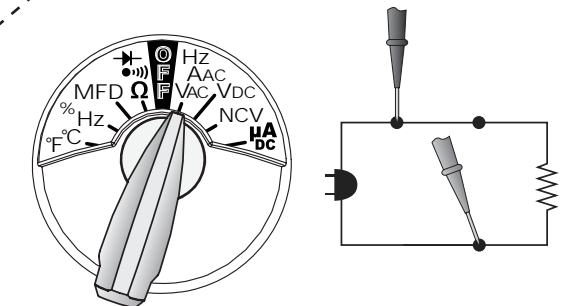
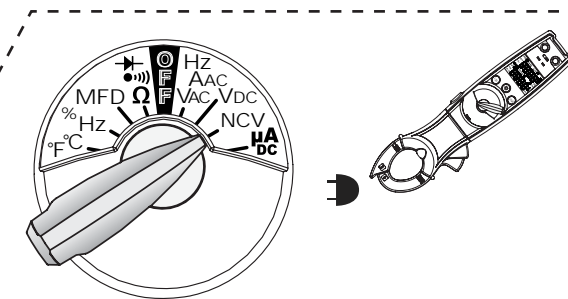
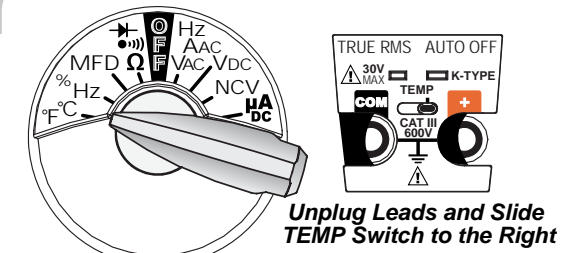

MicroAmps DC (μADC)

Microamps for flame rectifier diode test on a heater control. Connect leads between flame sensor probe and control module and turn heating unit on to read μA measurement. When the flame is on, there should be a measurable μADC signal, typically under 10μADC. Compare measurement to manufacturer's specification to determine if replacement is necessary.

Ranges: 500μA **Resolution:** 0.1μA
Accuracy: ±(1.0% + 2) **Voltage burden:** 1V
Overload Protection: 600VDC or 600VAC rms

Frequency (Hz) through Leads

Check Variable Frequency Drives. Check incoming voltages to ensure they are cycling at 60Hz or desired frequency.

Ranges: 500Hz, 5kHz, 50kHz, 500kHz, 1MHz **Resolution:** 0.1Hz
Accuracy: ±(0.1% + 5) **Sensitivity:** 10Hz to 1MHz: >3.5Vrms

Duty Cycle (%)

Duty cycle shows the % of the AC waveform which has positive amplitude. **Ranges:** 5%-95% (40Hz to 20kHz) **PW:** >10μs

Resolution: 0.1% **Accuracy (5V logic):** ±(2% + 10)

Capacitance (MFD)

Set to MFD to test motor start and run capacitors. Capacitors are one of the most failure prone components in a HVAC/R system. Discharge capacitor and disconnect from power and resistors between terminals before testing. If dI.S.C is displayed, discharge the capacitor.

Ranges: 5μF, 50μF, 500μF, 5mF **Resolution:** 1nF
Accuracy: ±(3% + 15) 5μF, ±(3% + 5) 50μF to 500μF, ±(5% + 20) 5mF
Overload Protection: 600VDC or 600VAC rms

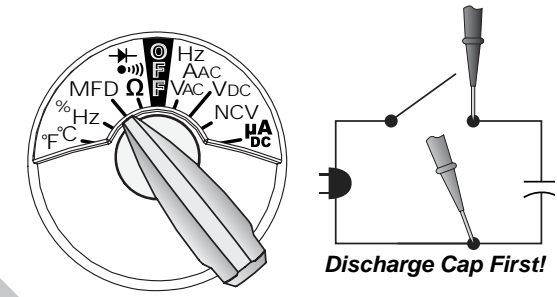
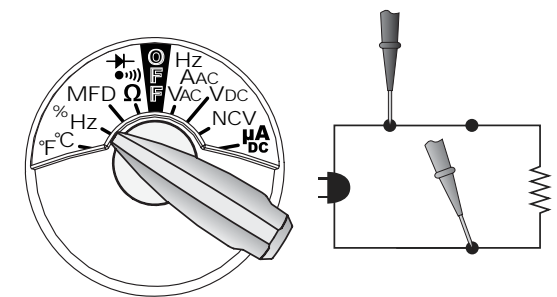
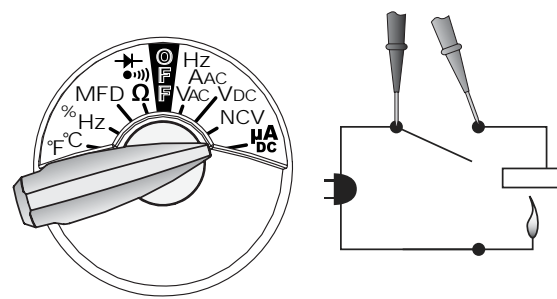

Voltage DC (VDC)

Select VDC and the range will automatically be selected to give the best resolution.

Ranges: 500mV, 5V, 50V, 500V, 600V **Resolution:** 0.1mV
Accuracy: ±(0.5% + 2)
Input impedance: >100MΩ (500mV), 10MΩ (5V), 9.1MΩ (50V-600V)

Resistance (Ω)

Used for "ohming out" a motor. 0.1Ω resolution is necessary to test the resistance between the motor poles because the values are typically very low.

Ranges: 500Ω, 5kΩ, 50kΩ, 500kΩ, 5MΩ, 50MΩ
Resolution: 0.1Ω **Overload Protection:** 600VDC/VAC rms
Accuracy: ±(1.0% + 5) 500Ω to 500kΩ, ±(1.5% + 5) 5MΩ, ±(3.0% + 5) 50MΩ

Continuity (•••)

Use the continuity feature to test if a circuit is open or closed. Use this feature to check fuses as well. A steady "beep" and green LED indicate the circuit is good. Turn dial to Ω position and press SEL button once.

Range: 500Ω **Resolution:** 0.1Ω **Response time:** 100ms
Audible beep: <30Ω **Overload Protection:** 600VDC/VACrms

Diode Test (→)

Test diodes for proper forward and reversed-biased functions. Turn dial to Ω position and press SEL button twice.

Test current: 0.8mA (Approx.) **Accuracy:** ±(1.5% + 5)
Overload Protection: 600VDC/VACrms

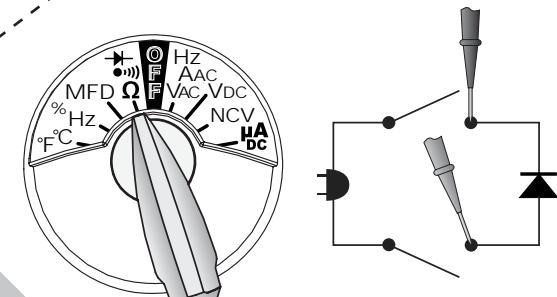
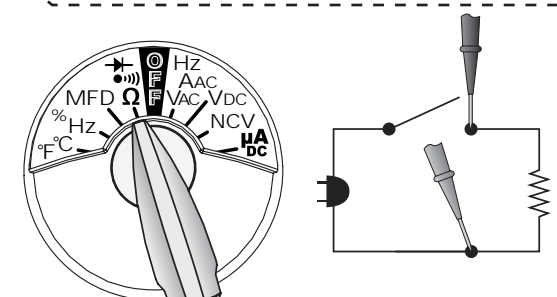
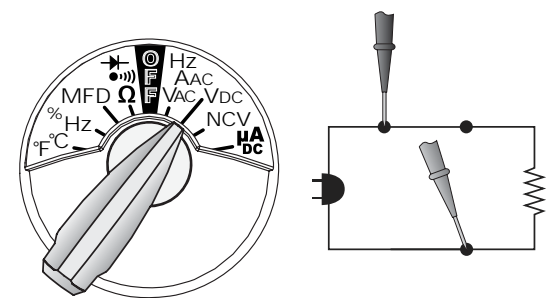

Amps AC (AAC)

Test any isolated power line. Press SEL on VAC/AAC/Hz position. AAC will display in the upper display. True RMS on model SC56 only.

Ranges: 50A, 400A **Resolution:** 0.01A **Crest factor:** ≤ 3
Accuracy: ±(2.0% + 10) 50-60Hz **Jaw Opening:** 1.2in (30mm)

Frequency (Hz) through Clamp

Measure frequency without using test leads, just use the clamp. Turn dial to VAC/AAC/Hz and press SEL twice. Clamp Hz upper display.

Range: 50Hz to 400Hz **Accuracy:** ±(0.1% + 5)
Minimum current range: > 5AAC **Overload Protection:** 400AAC
Resolution: 0.1Hz

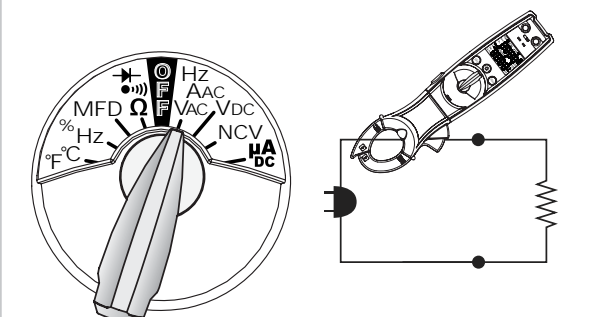

Inrush Current (SC56 only)

The Inrush feature captures the current at the beginning of the first 100ms period when a motor is started. This can help diagnose a motor before it fails. To activate Inrush, turn dial to VAC/AAC/Hz position, press SEL to show AAC on top display, then press the INRUSH button on the side of the meter once for 40AAC range and twice for 400AAC.

Inrush measurement period: 100-milliseconds

Modular Expandability

Your new Swivel Clamp Meter is compatible with all Fieldpiece Accessory Heads. With Fieldpiece Accessory Heads, you can measure any available parameter, and read the measurement on your new meter's display in real-time.

Just set the range to VDC and press the RANGE button until mV is displayed. Remove the probe tips of your test leads, and connect your accessory head (model AAV3 shown).

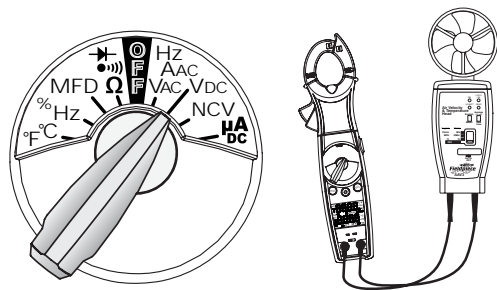

Visit www.fieldpiece.com to see all of the different accessory heads that Fieldpiece offers.

Temp. Calibration

For accuracies of ±1°F, calibrate to a known temperature. A glass of stabilized ice water is very close to 32°F (0°C) and is usually very convenient but any known temperature can be used.

1. Select the 400°F range.
2. Plug thermocouple to be calibrated into the K-type jack.
3. Unscrew A and B and remove the battery cover.
4. Stabilize a large cup of ice water. Stir the ice with the water until temperature stays at 32°F (0°C)
5. Immerse the thermocouple probe and let it stabilize. Keep stirring to prevent micro-environments.
6. Use a small screwdriver to adjust calibration pot C to the right of the battery as close to 32°F as you would like.

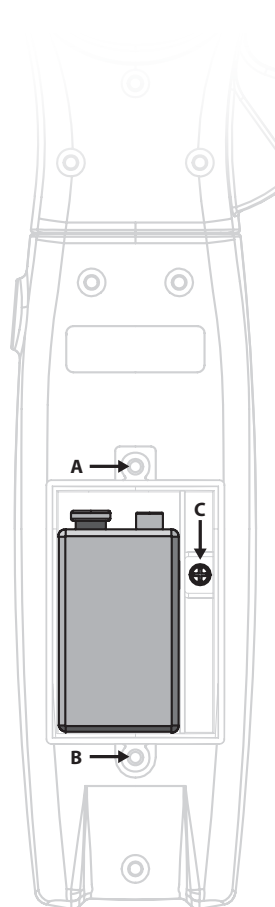

Safety Features

1. Bright LED and beeper warn you when testing voltages above 30V.
2. Switch to the NCV function (non contact voltage) and point clamp claw towards suspected voltage source. Monitor the bright LED and beeper to see if the source is "hot."
3. Rotate the clamp to the angle that best suits the situation.
4. Temp switch to prevent leaving thermocouple plugged in while measuring voltage.
5. LED flashlight automatically shines when clamp jaw is opened (model SC56 only).

Battery Replacement

The battery must be replaced when the battery icon is empty and blinking. The icon will blink for 30 seconds, then the meter will display LO.bt and further measurement will not be allowed until battery is replaced. Disconnect and unplug leads, turn meter off and remove battery cover. Replace the battery with a standard NEDA type 1604 9V battery.

Maintenance

Clean the exterior with a dry cloth. Do not use liquid.

Limited Warranty

This meter is warranted against defects in material or workmanship for one year from date of purchase. Fieldpiece will replace or repair the defective unit, at its option, subject to verification of the defect.

This warranty does not apply to defects resulting from abuse, neglect, accident, unauthorized repair, alteration, or unreasonable use of the instrument.

Any implied warranties arising from the sale of a Fieldpiece product, including but not limited to implied warranties of merchantability and fitness for a particular purpose, are limited to the above. Fieldpiece shall not be liable for loss of use of the instrument or other incidental or consequential damages, expenses, or economic loss, or for any claim of such damage, expenses, or economic loss.

State laws vary. The above limitations or exclusions may not apply to you.

Obtaining Service

Call Fieldpiece Instruments for one-price-fix-all out-of-warranty service pricing. Send check or money order for the amount quoted. Send the meter freight prepaid to Fieldpiece Instruments. Send proof of date and location of purchase for in-warranty service. The meter will be repaired or replaced, at the option of Fieldpiece, and returned via least cost transportation.



www.fieldpiece.com

© Fieldpiece Instruments, Inc 2010; v16